



Brake Systems

Added Value Solutions

Disk Brake Pads  
Drum Brake Linings

01/2020





Brake Systems

## ■ ABOUT US / HAKKIMIZDA

Haksan was established in Bursa, Turkey in 1988 by İbrahim GÜLMEZ, who is still the chamber of the boards, to produce rubber parts for the automotive sector.

The production adventure, which started with the compression molding method, developed in parallel to the changes in the sector and today it has become active in areas such as home appliances, construction, railways and defense industry as well as the automotive sector with injection molding of rubber elastomer, hose parts that have been strengthened with extrusion profile and textiles.

Haksan applies its own rubber recipe and produces rubber in its own factory. Rubber production in Turkey is one of the leading companies. Therefore, it provides a significant cost advantage in the production of rubber products.

Today Haksan serves its customers with its approximately 700 employees in Manisa and Russia centers with administration center in Bursa at 42.500 m<sup>2</sup> closed production area. With a turnover of 55.170.000,00 € in 2018, it ranks 118th among the companies in Bursa.

Our company which is one of the Haksan Group companies Hann Dağıtım Otomotiv Yedek Parça San.ve Tic.A.Ş. is manufacturing high quality Air Suspension System for the automotive industry like "Rolling Lobe Air Springs", "Roll-Metal Lobe Air Springs", "Multi-Convolute Air Springs" and "Cabin Air Springs" under the brand name "HANN" for busses, heavy-duty trucks, trailers, light commercial vehicles as well as for industrial applications. Our company is located in the Organized Industrial Zone.

Besides being a manufacturer, Hann Otomotiv is also a distributor for the brands that it has a strong partnership. Through the customer needs and demands, we provide and deliver the spare parts of trucks and trailer to our customers

The Hann brand has ISO / TS 16949: 2012 quality accreditation and aims to provide better service without sacrificing quality.

Hann, who made the ' to improve innovation continuously' as a principle, manufactures suitable with international quality standards and advanced analysis techniques. At that point, we pass our products through many tests and submit them to your valuable business partners.

At the same time, we guarantee that our products are manufactured in accordance with the original standards and also provide easiness of mounting.



Brake Systems

BRAKE PADS / DİSK FREN BALATALARI

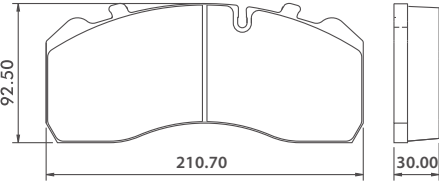
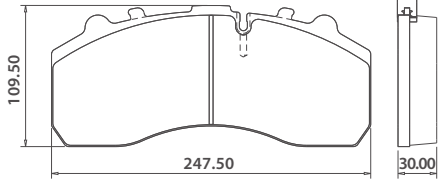
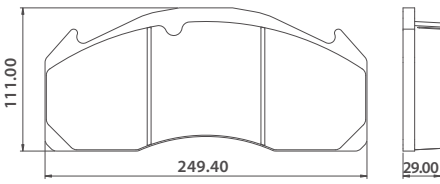
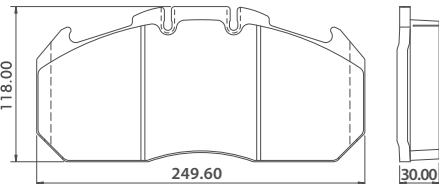
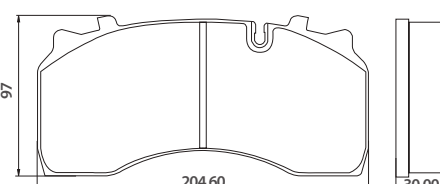
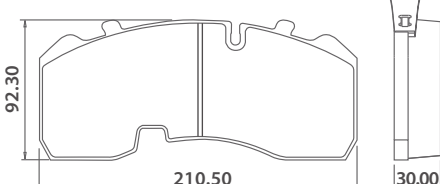
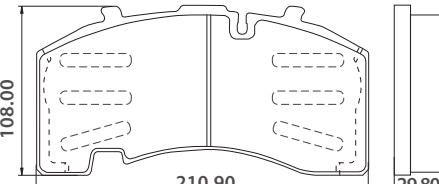
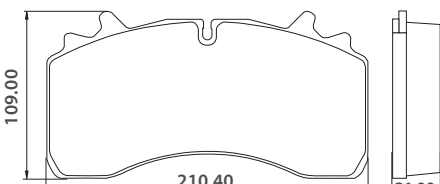
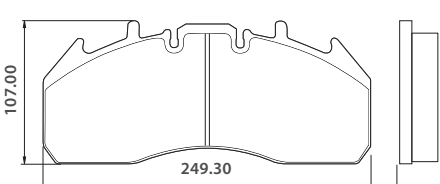
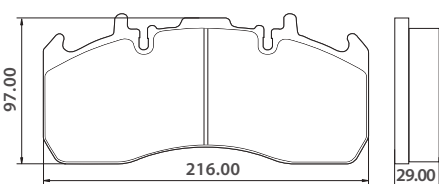
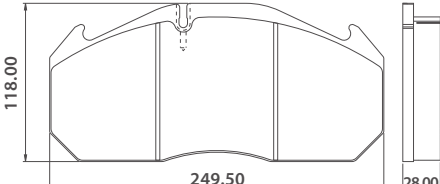
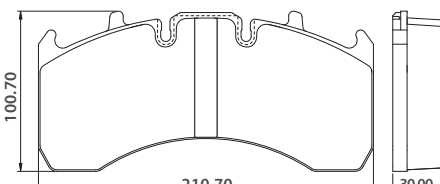
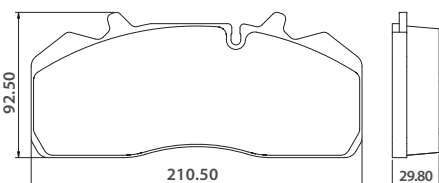
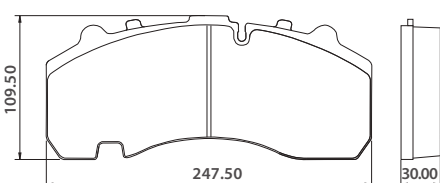
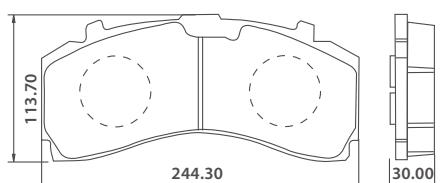

<p><b>H008D-301P Mercedes Atego - Man 2000</b></p>  <p><b>WVA : 29093 / 29095</b></p>	<p><b>H008D-300P Mer. , Man, Scania, Daf, BPW</b></p>  <p><b>WVA : 29087/29105/29106/29108 29109/29163/29179</b></p>	<p><b>H008D-125P Volvo FH 12 / FH 16</b></p>  <p><b>WVA : 29125</b></p>
<p><b>H008D-181P RVI Magnum - Premium, MAN</b></p>  <p><b>WVA : 29131/29156</b></p>	<p><b>H008D-142P RVI Midlum</b></p>  <p><b>WVA : 29141</b></p>	<p><b>H008D-165P Mercedes Atego, BPW</b></p>  <p><b>WVA : 29165</b></p>
<p><b>H008D-171P Saf, BPW</b></p>  <p><b>WVA : 29171/29271</b></p>	<p><b>H008D-303P Saf</b></p>  <p><b>WVA : 29162</b></p>	<p><b>H008D-174P RVI Magnum - Volvo FE-FM</b></p>  <p><b>WVA : 29174</b></p>
<p><b>H008D-173P RVI Midlum Volvo FL</b></p>  <p><b>WVA : 29173</b></p>	<p><b>H008D-497P Mercedes 403-404, Man, RVI</b></p>  <p><b>WVA : 29030/29113</b></p>	<p><b>H008D-169P Volvo FH, RVI Magnum-Prm.</b></p>  <p><b>WVA : 29169/29177</b></p>
<p><b>H008D-159P Saf</b></p>  <p><b>WVA : 29159/29126</b></p>	<p><b>H008D-167P BPW, Mercedes Actros-Axor</b></p>  <p><b>WVA : 29167</b></p>	<p><b>H008D-008P Mercedes (New Front/Yeni Ön)</b></p>  <p><b>WVA : 29246</b></p>

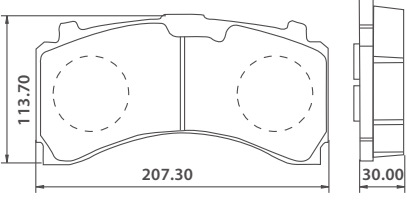
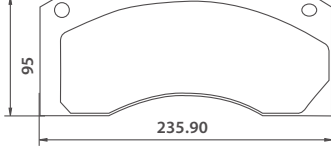
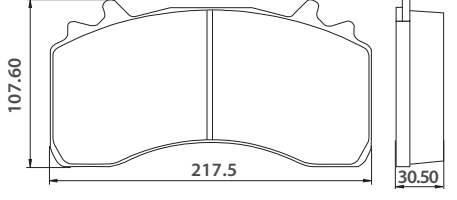
H008D-009 Mercedes (New Rear/Yeni Arka)	H008D-29044 Renault	H008D-279 Man TGX
 <p><b>WVA : 29244</b></p>	 <p><b>WVA : 29044</b></p>	 <p><b>WVA : 29279</b></p>

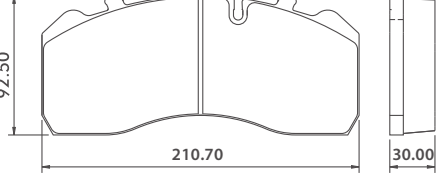
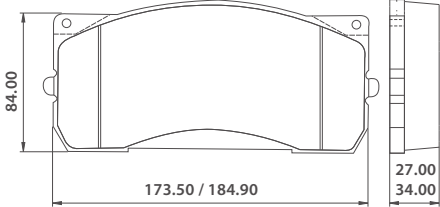
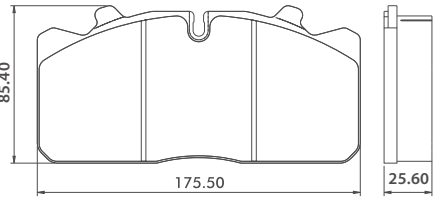
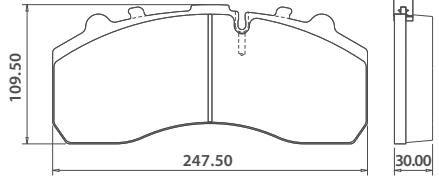
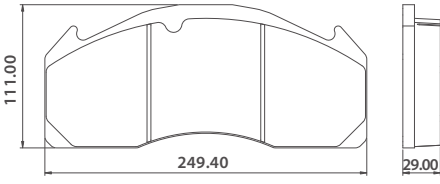
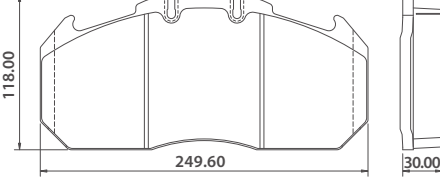
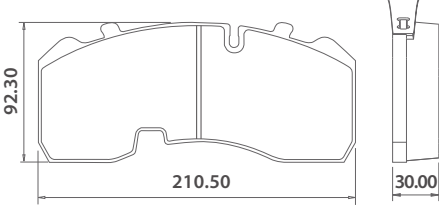
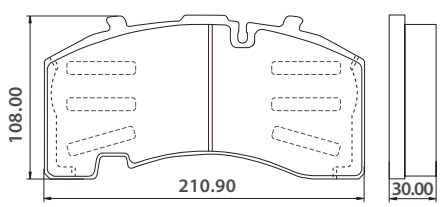
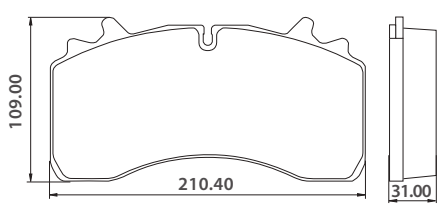
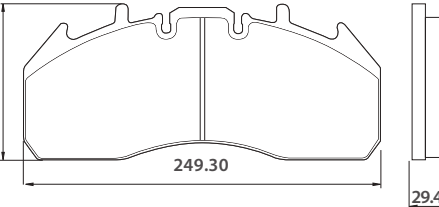
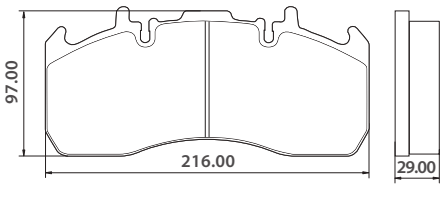
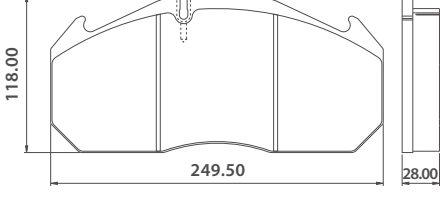
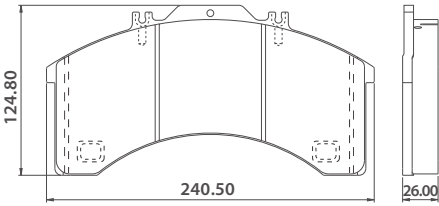
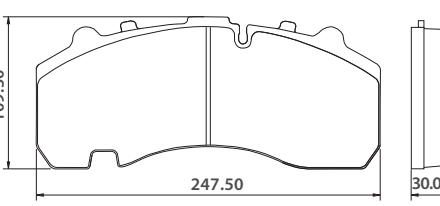
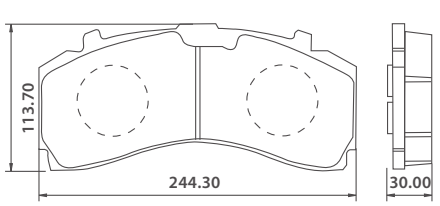
<p><b>H008D-301</b> Mercedes Atego</p>  <p><b>WVA : 29095</b></p>	<p><b>H008D-302</b> MAN TGL - BMC Probus</p>  <p><b>WVA : 29115/29148</b></p>	<p><b>H008D-565</b> MAN - RVI Midlum</p>  <p><b>WVA : 29088</b></p>
<p><b>H008D-300</b> Mer. , Man, Scania, Daf, BPW</p>  <p><b>WVA : 29087/29105/29106/29108 29109/29163/29179</b></p>	<p><b>H008D-125</b> Volvo FH12 - FH16</p>  <p><b>WVA : 29125</b></p>	<p><b>H008D-181</b> RVI Magnum - Premium, MAN</p>  <p><b>WVA : 29131</b></p>
<p><b>H008D-165</b> Mercedes Atego, BPW</p>  <p><b>WVA : 29165</b></p>	<p><b>H008D-171"</b> Saf, BPW</p>  <p><b>WVA : 29171</b></p>	<p><b>H008D-303</b> Saf</p>  <p><b>WVA : 29162</b></p>
<p><b>H008D-174</b> RVI Magnum - Volvo FE-FM</p>  <p><b>WVA : 29174</b></p>	<p><b>H008D-173</b> RVI Midlum Volvo FL</p>  <p><b>WVA : 29173</b></p>	<p><b>H008D-497</b> Mercedes 403-404, Man, RVI</p>  <p><b>WVA : 29030</b></p>
<p><b>H008D-525</b> Iveco Eurostar</p>  <p><b>WVA : 29011</b></p>	<p><b>H008D-167(Çentikli)</b> BPW, Mercedes Actros-Axor</p>  <p><b>WVA : 29167</b></p>	<p><b>H008D-008</b> Mercedes (New Front/Yeni Ön)</p>  <p><b>WVA : 29246/29247</b></p>

H008D-009 Mercedes (New Rear/Yeni Arka)

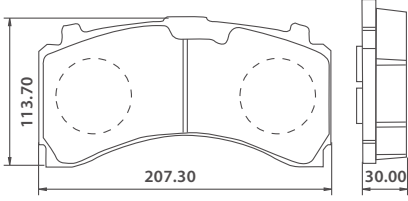

WVA : 29244/29245

H008D-228

BPW

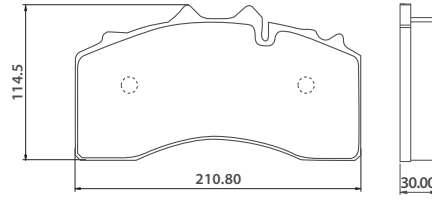

WVA : 29228

H008D-147

RVI Midlum (New / Yeni)

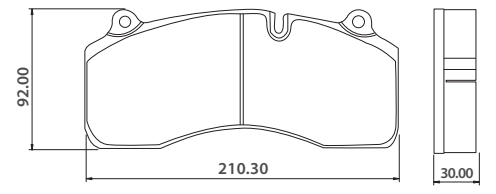

WVA : 29181/29207

H008D-195

SAF

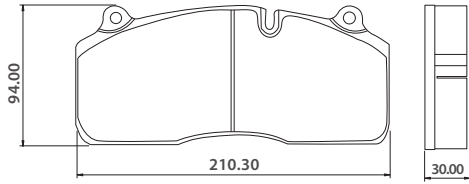

WVA : 29195

H008D-227

BPW

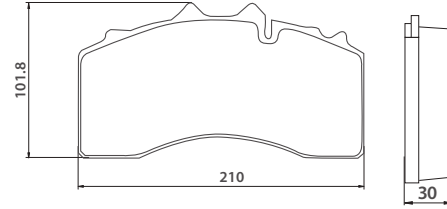

WVA : 29227

H008D-279

Man TGX

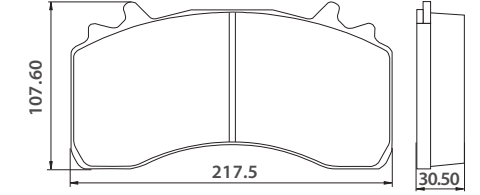

WVA : 29279



Brake Systems

BRAKE LININGS  
KAMPANA FREN BALATALARI







	HANN NO	REF NO	WVA NO	DESCRIPTION / ARAÇ ÇİNSİ	pcs. / ad.
1	H008-19369	E275/8	19369/19370	Muhtelif Dorse (22cm)	8
2	H008-19487	E623	19487	Mercedes Arka, MAN 22-190 (18cm)	8
3	H008-19488	E6268	19488	Süper MAN arka (22cm)	8
4	H008-19094	E687	19094	BPW - Boronkay Dingil (20cm)	8
5	H008-19032	E689	19032	BPW - Boronkay Dingil (18cm)	8
6	H008-19187	E875	19187	Renault Premium - Magnum Arka (22cm)	8
7	H008-19887	E878	19887	Fatih 162 - Ford Cargo - Iveco Euro Cargo (Ön/Arka/İlave) (18cm)	8
8	H008-19939	E880	19939	Dev Fatih 220-26 (Ön, Arka, İlave) (20cm)	8
9	H008-19938	E880/18	19938	Fatih Intercooler (Ön, Arka, İlave) (18cm)	8
10	H008-19935	E888	19935	Renault Tır (Arka) (18cm)	8
11	H008-19921	E878/20	19921	Ford Cargo Intercooler 2520 (Ön/Arka/İlave Dingil) (20cm)	8
12	H008-19036	E266	19036/19037	As 600-900 İlave dingil ve dorse (18cm)	8
13	H008-19037	E879	19036/19037	Dodge AS 900-950 Ön/Arka/İlave dingil (18cm)	8
14	H008-E879/1	E879/1	-	Dodge Askam Hi-Ex As 32-300 Ön (18cm)	8
15	H008-E879/20 f	E879/20 F	-	Dodge 26.200 Hi-Ex 32-300 Arka FRK (20cm)	8
16	H008-19486	E6250	19486	Mercedes , MAN Ön / İlave (16cm)	8
17	H008-19902	E688	19902/19903	BPW Dingil (20cm)	8
18	H008-19940	E881	19940	Dev Fatih Intercooler 270-26 Ön/Arka/İlave (22cm)	8
19	H008-19921	E878/20 F	19921	Ford Cargo Intercooler 2520 Ön/Arka/İlave dingil (20cm)	8
20	H008-E898	E898	-	Isuzu NPR 100P, Champion Ön/Arka	4
21	H008-17924	E4561	17924/17925	Iveco 65.9 Arka, Mercedes MB 800 Ön/Arka	4
22	H008-17635	E4563	17635/17636	Iveco 85.12 Arka	4
23	H008-E4572	E4572	-	Mitsubishi Canter 59 Ön/Arka	4
24	H008-E879/20	E879/20	-	Dodge 26.200 - 26.235 Ön / Arka / İlave Dingil (20cm)	8
25	H008-19553	E897/4	19553/19554	Ford Cargo 6x4 Damperli Y.M ( 20 cm )	8
26	H008-19580	E6265	19579/19580	Mercedes 302S - 303 Maraton Ön	8
27	H008-19581	E6266	19581/19582	Mercedes 302S - 303 Maraton Arka	8
28	H008-17991	E7251	17991	Scania P93 Ön -R113-MA320 Arka	4
29	H008-19931	E7252	19931	Scania P93 -P113-R143-R144 Ön	4
30	H008-19932	E7253	19932	Scania P93 8x4-R143 6x2	4
31	H008-19933	E7254	19933	Scania P93 -P113-R143-R144 Arka	4
32	H008-19283	E690	19283/19284	Dorse Saf Dingil ( 18 cm )	8
33	H008-19365	E697/8	19365/19366	Freuhauf Dorse	8
34	H008-19574	E1016	19574	BP Jumbo Dorse	8
35	H008-E1017	E1017		Freuhauf Jumbo Dorse	8
36	H008-19487/1	E623+1	19487+1	Mercedes Arka, MAN 22-190 (18cm)	8
37	H008-19488/1	E6268+1	19488+1	Süper MAN arka (22cm)	8
38	H008-19094/1	E687+1	19094+1	BPW - Boronkay Dingil (20cm)	8
39	H008-19487/2	E623+2	19487+2	Mercedes Arka, MAN 22-190 (18cm)	8
40	H008-19488/2	E6268+2	19488+2	Süper MAN arka (22cm)	8



	HANN NO	REF NO	WVA NO	DESCRIPTION / ARAÇ CİNSİ	pcs. / ad.
41	H008-19094/2	E687+2	19094+2	BPW - Boronkay Dingil (20cm)	8
42	H008-19486/1	E6250+1	19486+1	Mercedes , MAN Ön / İlave (16cm)	8
43	H008-19486/2	E6250+2	19486+2	Mercedes , MAN Ön / İlave (16cm)	8
44	H008-19931/1	E7252+1	19931+1	Scania P93 -P113-R143-R144 Ön	4
45	H008-19932/1	E7253+1	19932+1	Scania P93 8x4-R143 6x2	4
46	H008-19933/1	E7254+1	19933+1	Scania P93 -P113-R143-R144 Arka	4
47	H008-19562	E784	19562/19563	Volvo	8
48	H008-19790	-	19790/19791	Freuhauf	8
49	H008-19494	E6250	19494	Mercedes Benz - Van Hool	8
50	H008-19941	-	19941	Volvo	8
51	H008-19090	-	19090	AWD - Bedford - Volvo	8
52	H008-19071	-	19071	AWD - Bedford - Dennes - ERF-Seddon Atkinson- Steyr-Volvo	8
53	H008-19068	E881	19068	Dennes - Volvo	8
54	H008-19010	E4008	19011/19010	DAF ( 15 cm )	8
55	H008-19495	E623	19495	MAN - Mercedes Benz - Steyr - Van Hool ( 18 cm )	8
56	H008-19496	E6268	19496	MAN - Mercedes Benz - Steyr - Van Hool ( 22 cm )	8
57	H008-19900	E4016	19900-19901	DAF 95 Çekici Ön	8
58	H008-19890	E4015	19890-19891	DAF 95 Çekici / DAF 3300 Arka	8
59	H008-19116/1	E998+1	19116/19119+1	Iveco Trakker	8
60	H008-19116/2	E998+2	19116/19119+2	Iveco Trakker	8
61	H008-19365	-	19365/366 00	TRAILOR - L200 - L200	4
62	H008-E4317	E4317	-	Isuzu NQR	4
63	H008-19934	-	19934	Renault Midliner	8
64	H008-7066	-		Fruehauf	8
65	H008-7067	-		Fruehauf	-
66	H008-19553/1	-	19553/19554+1	Ford Cargo 6x4 Damperli Y.M ( 20 cm )	-
67	H008-19553/2	-	19553/19554+2	Ford Cargo 6x4 Damperli Y.M ( 20 cm )	8
68	H008-E4572/1	E4572+1	-	Mitsubishi Canter 59 Ön/Arka +1 Farklı	4
69	H008-19036	E266	19036/37	As 600-900 İlave dingil ve dorse (18cm)	4
70	H008-19580/1	E6265+1	19579/19580+1	Mercedes 302S - 303 Maraton Ön	4
71	H008-19580/2	E6265+2	19579/19580+2	Mercedes 302S - 303 Maraton Ön	4
72	H008-19581/1	E6266+1	19581/19582+1	Mercedes 302S - 303 Maraton Arka	4
73	H008-19581/2	E6266+2	19581/19582+2	Mercedes 302S - 303 Maraton Arka	4
74	H008-19090/1	E880/17,5+1	19090+1	AWD - Bedford - Volvo	8
75	H008-19071/1	E880+1	19071+1	AWD - Bedford - Dennes - ERF-Seddon Atkinson- Steyr-Volvo	8
76	H008-19369	E275/8	19369/19370-6MM RIV	Muhtelif Dorse	4
77	H008-19365/1	-	19365/19366 + 1	Freuhauf Dorse	4
78	H008-19939	E880/20 F	19939	Dev Fatih 220-26 (Ön, Arka, İlave) (20cm) ( Farklı )	8

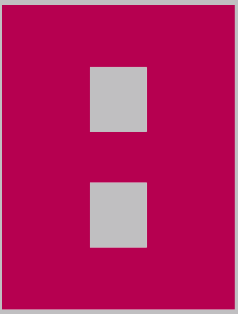

**HANN**

Brake Systems

**HANN DAĞITIM OTOMOTİV  
YEDEK PARÇA SANAYİ VE TİCARET A.Ş.**

Organize Sanayi Bölgesi Sarı Cad. No:10/A Nilüfer / Bursa / Türkiye

Telefon : +90 224 411 11 34

Fax : +90 224 411 11 43

**[www.hannotomotiv.com](http://www.hannotomotiv.com)**